



DRS602

6.5" High Performance Coaxial

CARACTERISTICAS

- Nominal 60 Watts
- Dinámico de 240 Watts
- Tweeter con Domo de Seda
- Bobina de 1" KSV
- Cono de Fibra de Vidrio
- Amortiguador de Goma
- Magneto de Oxido Ferroso
- Canasta de Acero Estampado
- Parrilla Incluida
- Frecuencia de Trabajo: 38Hz – 20KHz
- Sensibilidad: 90dB

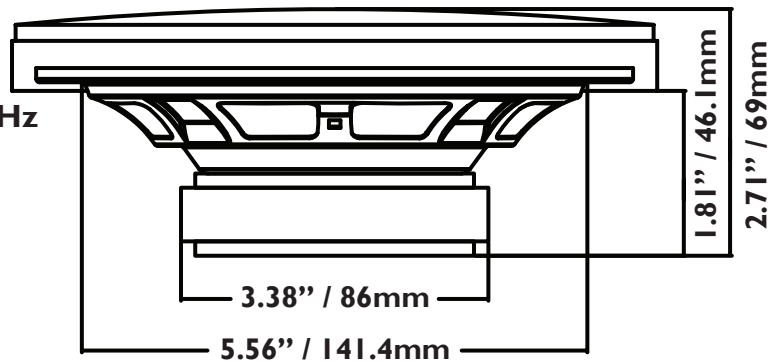
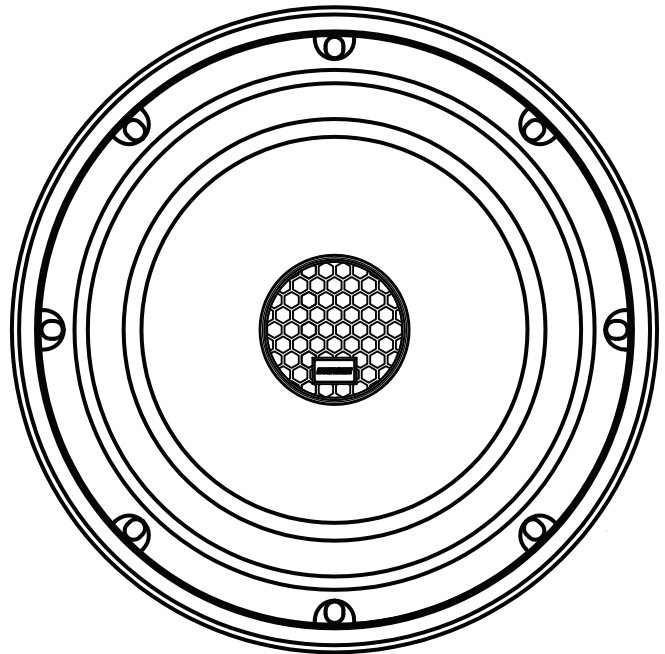

Driven is a Registered Trademark of DB Research L.L.P. | Designed and Engineered in the U.S.A.



DRS602

6.5" High Performance Coaxial

FEATURES

- Nominal 60 watts
- Dynamic 240 watts
- Silk Dome Tweeter
- 1" KSV Voice Coil
- Glass Fiber Cone
- Rubber Surround
- Ferric Oxide Magnet
- Stamped Steel Basket
- Grill included
- Frequency Response: 38Hz – 20KHz
- Sensitivity: 90dB

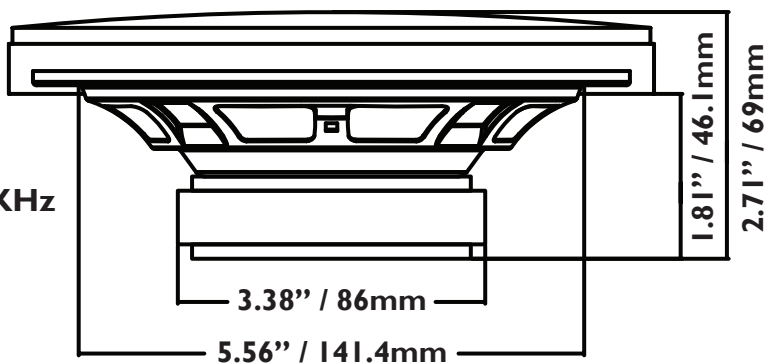
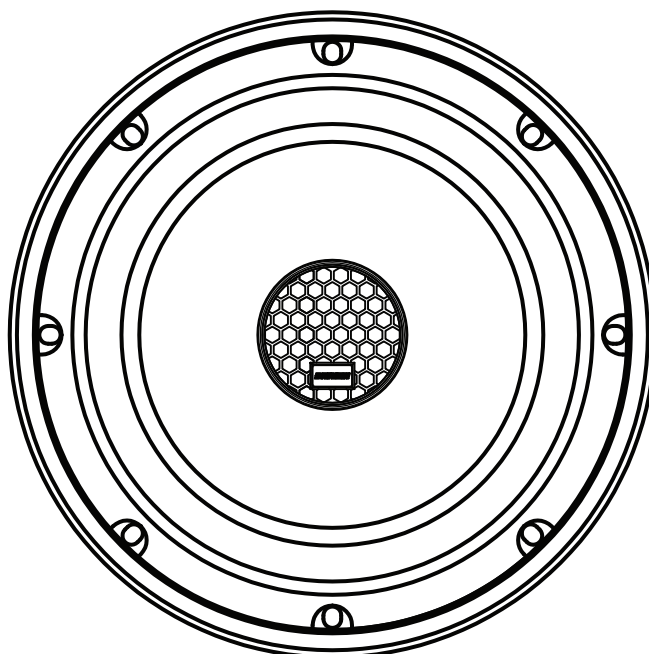

Driven is a Registered Trademark of DB Research L.L.P. | Designed and Engineered in the U.S.A.